

JINHU 金湖集团
JINHU GROUP

JINHU
金湖集团
JINHU GROUP
金湖
JH®

唯有好的机器，才有好的未来
GOOD MACHINE
RESULT IN HIGH QUALITY PRODUCT

SHEET BOARD MATERIAL Extrusion Equipments

板材·片材挤出设备

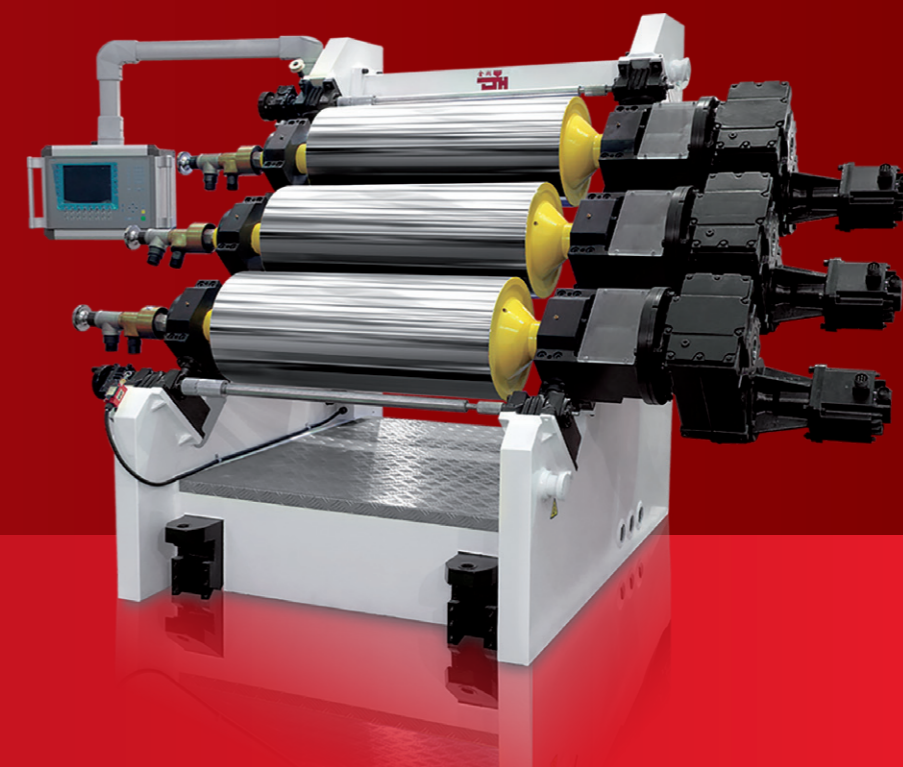

地址：上海市曹安路 4246 号（20 号桥西）
Add: 4246 Caoan Road, Shanghai, 201804 P. R. CHINA
销售部 (Sales Tel) : 0086-21-69595095 69595096 69595070
外贸部 (Trade Department Tel) : 0086-21-69591860 69595138
售后热线 / 传真 (Service Hotline/Fax) : 0086-21-69595223 69592961
传真 (Fax) : 021-69595125 69593603
E-mail: jinhush@jinhu-china.com
http: //www. jinhu-china.com



JINHU 2019.04 ZHONGMENG media

上海金湖挤出设备有限公司
SHANGHAI JINHU EXTRUSION EQUIPMENT CO.,LTD.

上海金湖机械有限公司
SHANGHAI JINHU MACHINERY CO., LTD.

上海金湖塑料机械有限公司
SHANGHAI JINHU PLASTIC MACHINERY CO.,LTD.



质量管理体系符合
GB/T19001-2000 idt ISO9001:2000标准

金湖人的意识

CONSCIOUSNESS OF JINHU PEOPLE

金湖人在销售上需要主动热情地了解市场的波动、新产品的开发、同行的信息、市场的信息、服务的信息和需求的信息。加强自我的形象、信息的反馈、产品的更新、合作的意识、客户意识、公司的保密意识。

金湖人在生产上需要加强自我的成本意识、质量意识、生产意识、效率意识、规范意识、管理意识、安全意识。质量是生产出来的，不是检查出来的。

金湖人在服务上需要主动、热情、定期、不定期的服务。加强自我形象、不断加强自我的服务意识、销售意识、客户意识、市场意识、成本意识、沟通意识和朋友意识。站在主人翁的角度来要求自我的工作。

金湖人在技术上需要快、简单、实用、更经济的精神，也需要一丝不苟、十全十美的精神。不断加强企业的竞争意识、市场意识、成本意识、客户意识、品牌意识。提高自我的专业技术、不断学习新的知识和设计理念。

金湖人在管理上需要以成为公司制度的楷模为目标，从我做起互相监督、站在企业的角度来考核自我的一切工作。从工作安排、计划、监督、检查、反馈、考核、服务等等。以高标准、严要求、制度化来开展自我的工作，一切以效率为主、以质量为核心、团结为后盾，发挥金湖的真诚合作、求实拼搏的精神。

金湖人有了目标、有了责任、有了方法，我们才会不断地去要求自我认真，一位不苟、持之以恒地提高自我的工作质量，提高自我的生活质量，加强自我的社会责任感，为社会文明而努力奋斗。

Initiative and enthusiasm in the market, and understand the volatility of the market, new product development as well as information of opponent market, service and demand. Strengthening ego image, information feedback, product updates, sense of cooperation, customer awareness, and the company's confidential consciousness.

Jinhu people have to strengthen the self production cost awareness, quality consciousness, production consciousness, efficiency consciousness, standard consciousness, managing consciousness and safety consciousness. Quality is in the production, not in the examine.

Jinhu people are always active and warm in services, periodically and periodically to service customers. Strengthening Jinhu people's self-image and self service consciousness, sales consciousness, customer awareness, market consciousness, cost awareness, communication and friends consciousness continuously. Standing in the angle of self to request the masters.

Jinhu people always have the perfect spirit of fast, simple, and practical, more economical and more meticulous in technical; strengthening the competitive enterprise consciousness, market consciousness, cost consciousness, customer awareness and the brand awareness constantly. Improving the self professional technology and learning new knowledge and design concept constantly.

People always form ourself as model base on a formula system in management. We begin from ourself and supervise each other, all our work will standing in the point of view of our enterprise to assessment ourself from working arrangement, plan, supervise and inspect, feedback, assessment and service, etc. With high-standard requirements and institutionalized to develop our work, with priority work to the efficiency and take the core work to the quality, we Jinhu people unite and cooperate each other to develop the sprit of Jinhu people's sincerity cooperation and fact attitude.

Only Jinhu people have the target the responsibility and the methods, then we can improve our workmanship, the quality of life and the sense of social responsibility to strive for our social civilization continuously and fastidiously.

中国民营 500 强
上海民营企业 100 强
浙江省民营企业 50 强

企业宗旨

真诚合作 求实拼搏 不断创新 永争第一

Enterprise Tenet

Sincere Cooperation Practicality and Striving
Continuous Innovation Being the First Forever



董事长：何青雷
President: ChunLei He

中国优秀民营科技企业家、浙江省政协委员、
浙江省工商联会常委、舟山市政协常委、舟山市工商联会副会长、
舟山市企业家协会副会长、舟山市海外联谊会副会长

China Excellent entrepreneur for Private Hi-tech Business

Member of Zhejiang Committee of CPPCC

Member of Standing Committee of Zhejiang Industrial & Commercial Association

Member of Standing Committee of Zhoushan Municipal Committee of CPPCC

Vice-chairman of Zhoushan Industrial & Commercial Association

Vice-chairman of Zhoushan Enterprise Directors Association Vice-chairman of

Zhoushan Overseas Friendship Association

金湖集团凭着其多年酝酿的独特企业文化，以及企业对全球经济发展的热切关注，以磅礴的气势和迅捷的反应不断壮大，使自己在本行业中深具规模，倍受瞩目。集团从事塑料机械制造长达 33 年之久，在上海、浙江设立了五个生产基地，拥有舟山金海机械有限公司、舟山金湖化纤机械有限公司、浙江金湖塑料机械有限公司、上海金湖挤出设备有限公司、上海金湖机械有限公司、上海金湖塑料机械有限公司等十多家公司。总占地面积达 1200 多亩，员工人数千余名，其中包括各类技术人员 400 多名。公司产品使用“金湖”注册商标。在公司

员工的不断努力下，公司先后获得“中国民营企业 500 强”、“上海市百强民营企业”、“浙江省百强民营科技企业”、“浙江省诚信企业”、中国轻工优秀民营百强企业”、“中国机械优质产品”、“中国十佳塑料机械企业”等荣誉称号。此外，公司还拥有独立的质检中心，并取得中国质量协会质量管理体系认证，其质检水平具有较高的权威性、公正性及可靠性。



位于舟山经济开发区 B 区的生产基地 (金湖集团)
Jinhu Group in Section B of Zhoushan Economic and Technological Development Zone ETDZ



位于舟山经济开发区 A 区的生产基地 (金海机械)
Jinhai Machinery, Located in Section A of Zhoushan Economic and Technological Development Zone (ETDZ)



位于上海黄渡工业园区的生产基地 (一分公司)
Production Base (HUANGDU INDUSTRIAL PARK OF SHANGHAI)



上海曹安公路 4246 号 (上海金湖挤出设备有限公司)
The manufacturing base at Shanghai Huangdu Industrial Park Shanghai Jinhu Extrusion Equipment Co., Ltd.

JINHU treats people as the base and seeks development by innovation. With its distinct enterprise culture and rapid reaction, it has owned certain scale. This group has been in the line of plastic machinery for more than 33 years, so far it has established five production bases in Shanghai, Zhejiang. It owns ten specialized companies such as Zhou Shan Jinhai Machinery Co., Ltd., Zhou Shan Jinhu Chemical Fiber Machinery Co., Ltd., Zhejiang Jinhu Plastics Machinery Co., Ltd., Shanghai Jinhu Extrusion equipment Co., Ltd., Shanghai Jinhu Machinery Co., Ltd...etc. Its total area exceeds 1200 Mu; it has more than one thousand staff including more than 400 technicians. JINHU is one registered trade marks of this Group Co.. With common efforts of all staff, this group Co. has got a lot of honors, such as "Top 500 China's Private Enterprise"; "Top 100 Shanghai's Private Enterprise", "Excellent Top 100 Private Scientific & Technological Enterprise in Zhejiang Province", "Honest & trustworthy Enterprise in Zhejiang Province", "Excellent Top 100 Private Enterprise in China's Light Industry", "Excellent Quality Product of China's Machinery", ...etc. In addition, this Group Co. has independent quality inspection center, and has obtained certain certificate from China Quality Association with rather high authority, justness and reliability.

质量是企业的生命、技术是企业的源泉、管理是企业的核心、人才是企业的根本、服务是企业的宗旨。

The quality is the life of enterprise, the technology is the mine of enterprise, the management is the core of enterprise, the talents is the foundation of enterprise, and the service is the purpose of enterprise.

金湖塑机、塑机金湖、金湖为人人、人为金湖、金湖努力为社会服务、金湖以品质、科技、节能、高效、创新的社会化的责任感而努力奋斗。

金湖集团的主要产品有：各类塑料管道生产线；各类塑料异型材生产线；各类塑料板材、发泡板、片材、流涎膜生产线；各种用途的单螺杆、双螺杆挤出机；平行双螺杆挤出机；各类塑料机械用螺杆、机筒；化纤卷绕头及化纤成套生产设备；各类优质水环式真空泵，高可靠性水泵，热油泵及液压系统，热恒温系统；电工电缆机械；化工成套设备；齿轮减速机箱等。产品远销东南亚、中东、南美、欧共体等国家。在产品质量上精益求精，在技术上不断完善，在售后服务上建立了全国完善的网点服务体系，成为全国塑机行业中发展最快的、技术最强的优秀企业，深得用户的好评。我们的优势在于不断为用户提供优质、可靠、价格合理的新产品，帮助用户创造最大的利润和商机是我们最终的目标。

In 2002, this Group Co. has imported HVOF alloy powder spray equipment and 2 sets CNC milling machine for screw & barrel to insure products processing precision, thereby the screw & barrel get a good stiffness and toughness property, prolong service life. JINHU GROUP mainly provides all sorts of plastic pipe production line, all sorts of profiled production line all sorts of plastic Board, Sheet, Film production line, all sorts of single and twin screw extruder, all sorts of screw & barrel for plastic machinery, winding head for chemical fibers and chemical fiber complete set

of production equipment, all sorts of excellent water cycled type vacuum pump, high reliability water pump, hot oil pump and pneumatic system, thermal constant temperature system, electrical cable machinery, chemical complete set of equipment gear box...etc. Products are exported to such countries and regions as Southeastern Asia, mid-east, South American, EU...etc. Always improving and developing the quality of products and have established complete nation-wide service network. It has developed into the strongest enterprise in national plastic machinery industry. Our advantages lie in that we continuously provide new items with excellent quality and reasonable price. It is our ultimate target to help our customers to create best profit and business opportunity.

JINHU for plastic machinery, plastic machinery by JINHU; JINHU for All, All for JINHU. JINHU performs its responsibility do it best to serve society with a high quality & technology, high-efficient energy saving and innovative products.

Screw & Barrel

Of Single Screw Extruder

单螺杆挤出机螺杆机筒

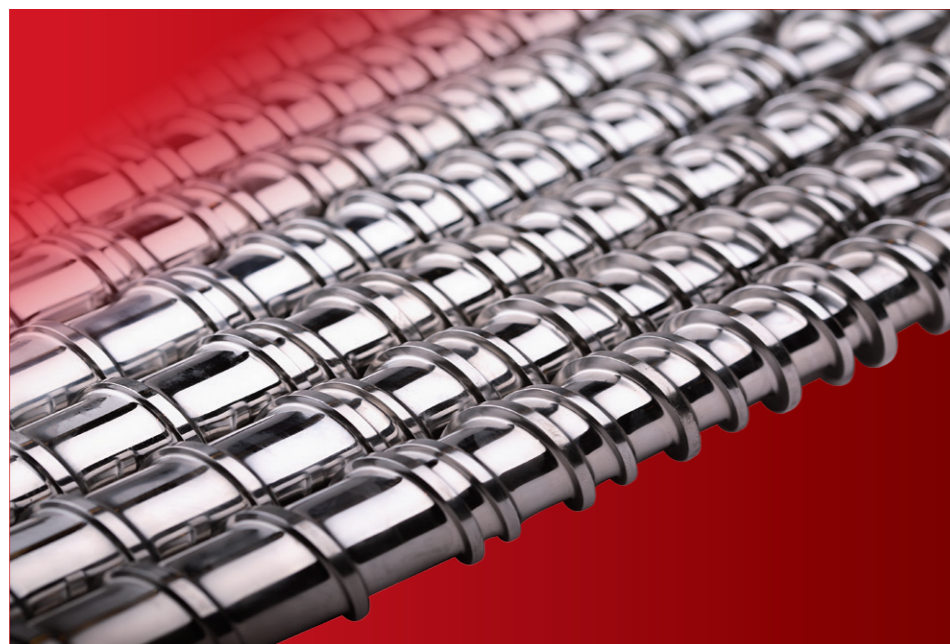

材料 Material

优质合金钢 High quality alloy
1) 38 CrMoAlA(JIS SACM645)
2) 42 CrMo(JIS SCM440)
3) 9 Cr18MoV
4) CW6Mo5Cr4V2
5) SKD61

热处理

渗氮处理
电镀硬铬层
高频淬火
喷涂耐腐蚀、耐磨双金属层
真空淬火

Heat treatment

Nitride treatment
Hard chrome plating
High frequency quenching
Spraying bimetallic alloy for corrosion resistance & abrasive resistance
Vacuum quenching

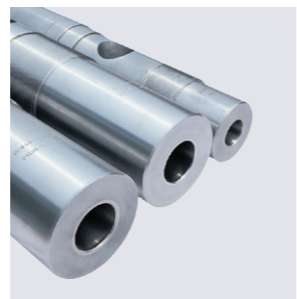
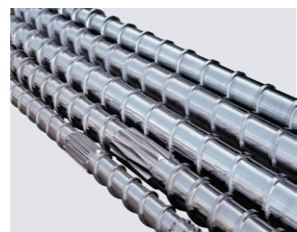

Conical (Parallel)

Twin Screw & Barrel

锥 (平) 双螺杆机筒

材料

优质合金钢
1) 38 CrMoAlA(JIS SACM645)
2) 42 CrMo(JIS SCM440)
3) 9 Gr18MoV
4) CW6Mo5Cr4V2

Material

High quality alloy
1) 38 CrMoAlA(JIS SACM645)
2) 42 CrMo(JIS SCM440)
3) 9 Gr 18MoV
4) CW6Mo5Cr4V2

热处理

渗氮处理
电镀硬铬层
喷涂耐腐蚀、耐磨双金属层

Heat treatment

Nitride treatment
Hard chrome plating
Spraying bimetallic alloy for corrosion resistance & abrasive resistance

技术指标

氮化层深度 :0.50-0.80mm
氮化硬度 :900- 1000HV
氮化脆性 : ≤一级
表面粗糙度 :Ra0.4
螺杆直线度 :0.01 5mm
氮化后表面镀铬硬度 : ≥ 950Hv
镀铬层厚度 :0.025-0.085mm

Technical index

Nitride thickness 0.50m-0.80mm
Nitride hardness. 900 000HV
Nitride fragility First class
Surface roughness: Ra0.4
Screw straightness 0015mm
Chrome layer hardness ater nitride: z950HV
chrome layer thickness. 0.025-0.085mm

表面处理

渗氮处理
喷涂耐腐蚀、耐磨双金属层

Surface treatment

Nitride treatment
Spraying bimetallic alloy for corrosion resistance & abrasive resistance



PC. PMMA.PS.MS

Sheet Production Line

PC、PMMA、PS、MS 板材生产线

特点:

- 1、透光性:透光性能好、耐老化;
- 2、耐候性:表面 UV 共挤处理,不受紫外线破坏;
- 3、抗冲击:抗冲击强度是普通玻璃的 250-300 倍;
- 4、阻燃性:国家 GB8624-97 测试属阻燃 B1 级,无火滴、无毒气;
- 5、耐温性:PC 板在 -40℃ to +120℃ 的范围内不影响板材质量,物理性质稳定;
- 6、轻便性:重量轻便于搬运、安装、可直接冷弯曲、热成形性能好;
- 7、隔音性:隔音性佳,在国内外是高速公路等隔音屏障的首选材料。
- 8、加工范围:最大宽度 2 米,厚度范围:1.5-15 毫米

Feature

- 1.Transparence: superior transparent and aged-resistance.
- 2.Radiation-resistance: UV layer co-extrusion, preventing ultraviolet radiation from damaging.
- 3.Impact-resistance: its impact-resistance is 250-300 times more than normal glass.
- 4.Fire-resistance: GF8624-97 test, belongs to fire-resistant B1 class, none burning drop, none toxic gas.
- 5.Heat-resistance: it's not affected its quality and physical performance under a circumstance of -40 C to +120 C .
- 6.Portability: light weight, easy to move, install. Good thermoforming capability.
- 7.Sound insulation: superior sound insulation, mainly used for sound insulation material on the highway.
- 8.Production seope: Max width 2000mm. Thicknoss 1.5-15mm.

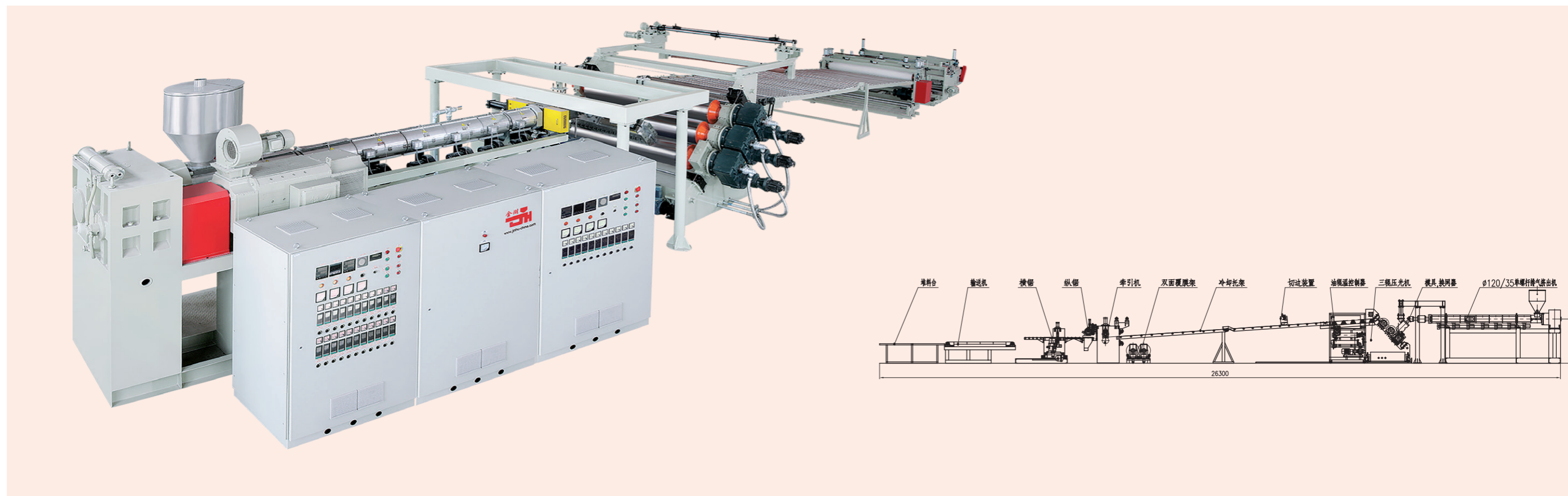
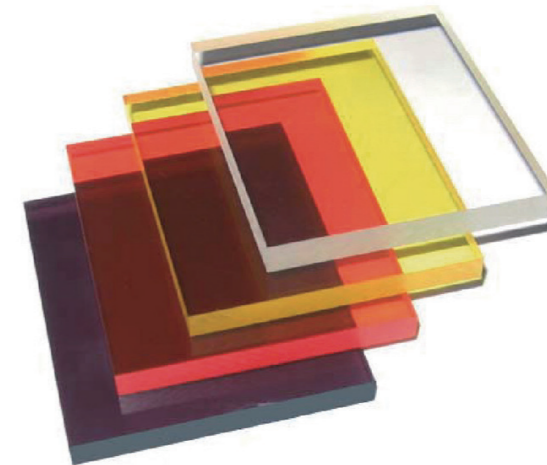

PP.HIPS.PE.EVA EVAOH Single Layer

Multi-layers Composite Sheet Production Line 单层、多层复合片材生产线

PP、HIPS、PE、PET、EVA、EVAOH 片材

具有强度高，耐温，防腐性能好，可进行填充，增强，增韧，增刚，阻燃，改性，表面可压花、磨砂。
适用于各行各业之产品包装、食品包装、文具、印刷、礼品及工艺品制造等。主要产品：礼品袋、广告扇、文件袋、灯罩、鼠标垫、食品包装盒等。

加工范围：厚度 0.2-2mm 宽度 600-1800mm

PP, HIPS, PE, EVA, EVAOH Composite Sheet

It has such characteristics as high intensity, good temperature resistance, good rot proof, etc. it can be produced with additives to different requirement such as improving intensity, improving toughness, improving rigidity, flame retardant, embossing, frosting, etc.

Applications: such as packing, printing, stationery, art works, etc. main product: gift/ad/file bag, lamp cover, food packing, etc.

Production scope: thickness 0.2-2mm width 600- 1800mm

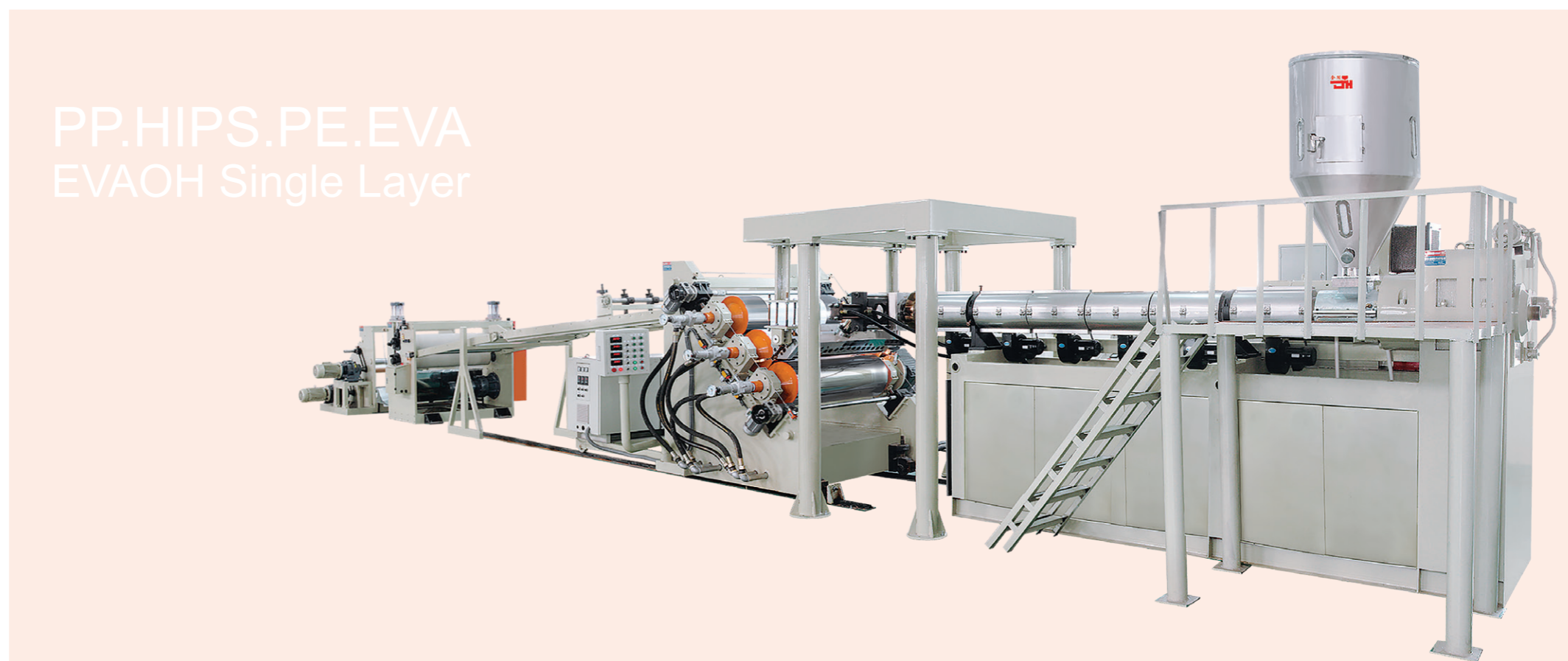
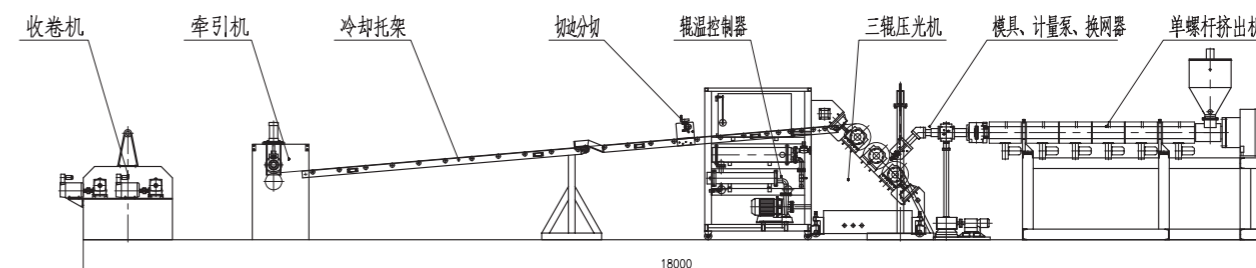

PP, PE

Board Production Line

PP、PE 厚板生产线

PP、PE 厚板:

耐冲击, 耐腐蚀, 耐热性高, 无毒无味, 表面光滑美观, 低密度重量轻, 加工容易, 尺寸稳定好, 刚性, 耐热性好, 焊接时不会产生毒气。

应用范围: 线路板及金属表面处理缸槽、线路板湿法处理设备、厂房废气排放系统设备、废水及其他环保系统设备、半导体工业相关设备, 还可进行填充, 阻燃, 改性, 表面可压花, 磨砂。加工范围: 厚度 3-30mm 宽度 3000mm 以内

PP, PE Board

It has such characteristics as high impact resistance, high rot resistance, high temperature resistance, non-toxic, smooth surface, light, easy to thermoform, etc. Applications: such as wire plate, environment protection material, venting equipment, semiconductor equipment, etc.

Production scope: thickness 3-30mm width 3000mm(under)

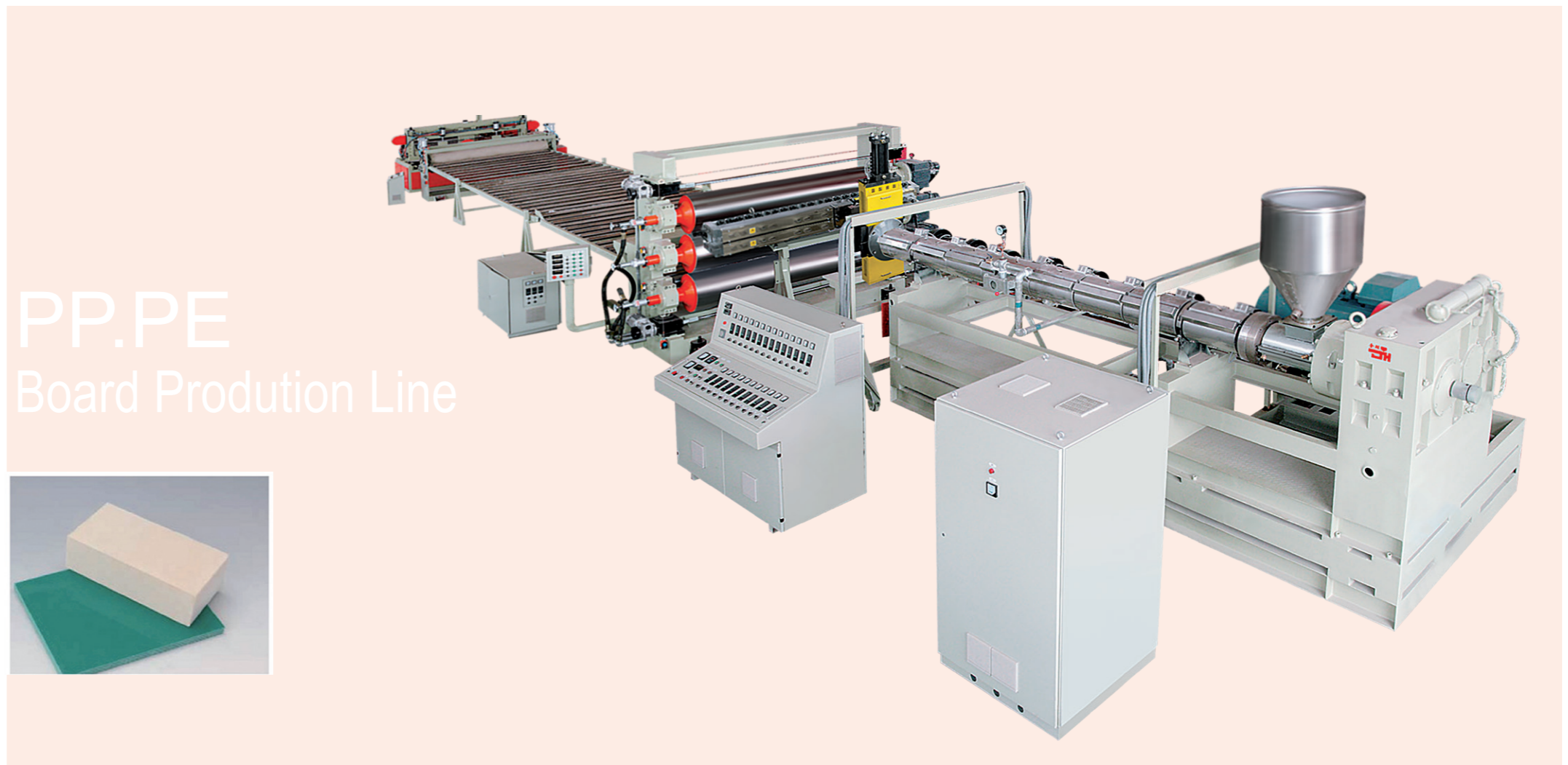
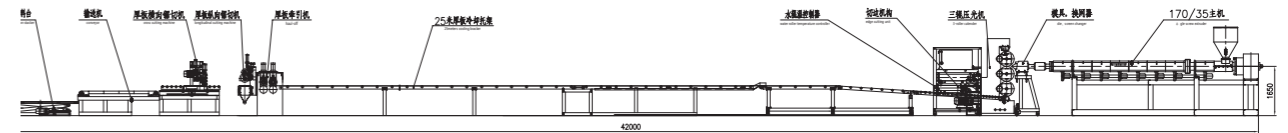

PP, PE
Board Production Line

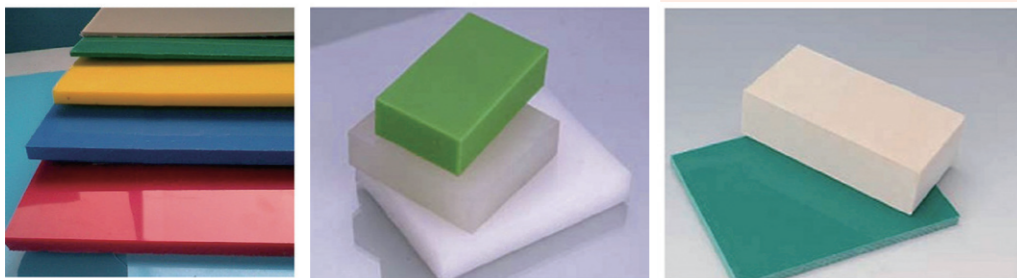

PMMA

Transparent Sheet Production Line

PMMA 镀膜片生产线

用途:

广泛用于仪器、仪表零件、火车、飞机、电梯、镜子。
电子产品：电视、电脑屏幕。工艺制品：标本、标牌、
银行柜台、超市、文教等生活用品。

产品加工范围:

厚度 0.8-10mm 宽度 800-2000mm

Applications

It has such applications on electric apparatus, train, elevator, aeroplane
decorating, artworks, etc.

Production Range

thickness: 0.8~ 10mm, width: 800~ 2000mm

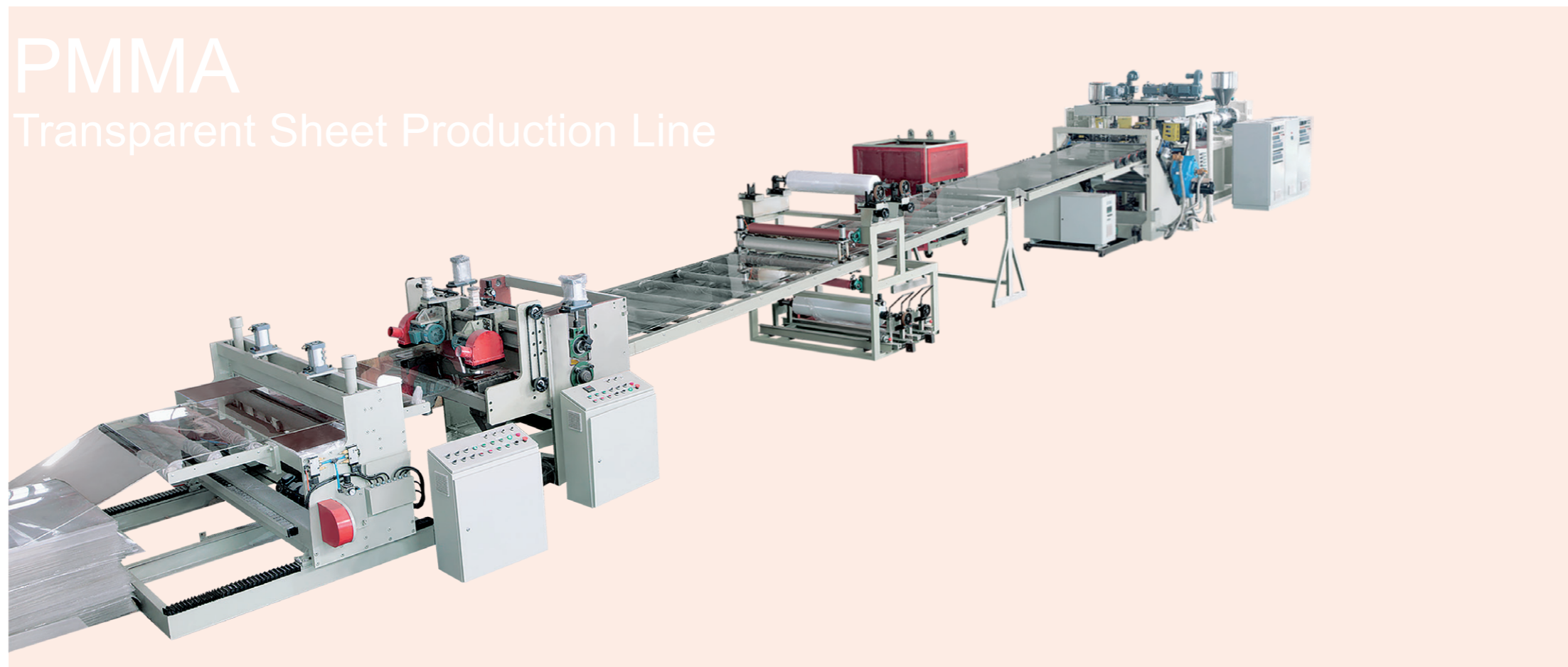
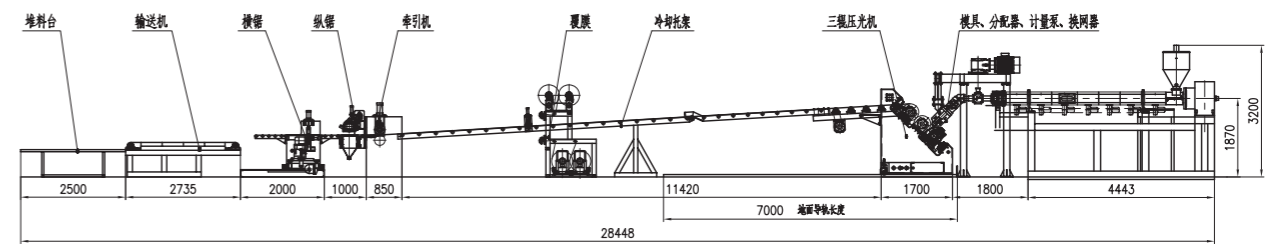

PMMA

Transparent Sheet Production Line

PC.PP

Hollow Profile Board Production Line

PC、PP 中空格子板生产线

该设备用于 PC、PP、PE 中空板的生产。产品广泛用于建筑、装饰、广告布置、公路噪声隔离以及包装。PP 中空板材可替代纸箱做包装箱，质量轻、强度高、防潮、防腐。板材成品宽度 1220-3000mm，厚度 2-16mm。车站、停车场、凉亭、体育场馆、公共设施采光、农业养殖、蔬菜大棚游泳池天幕、家庭卫生家淋浴房等。

The equipment is applicable to produce PC、PP hollow profile board. The products is used widely for building, decorating, advertisement laying, road noise isolation and packing. PP hollow profile board can instead of carton which have feature like light weight, high strengthen, moisture-proof, antiseptis. Width of board is 1 220-3000mm and thickness is 2- 16mm. Bus station, stadium, publics daylighting, agriculture, bathroom, etc.

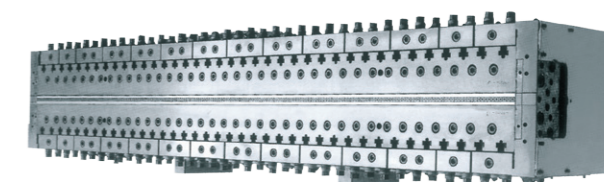
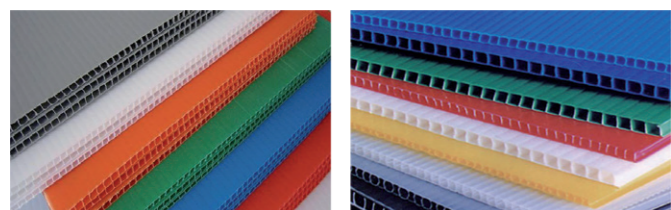
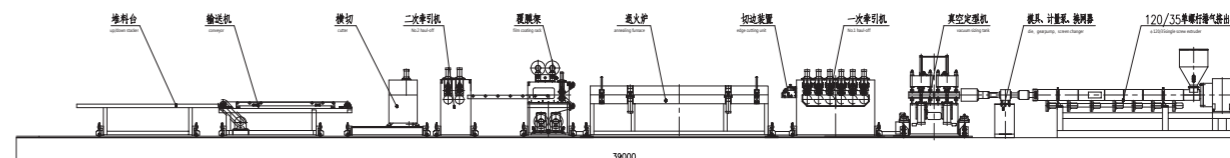

PC.PP Hollow Profile Board Production

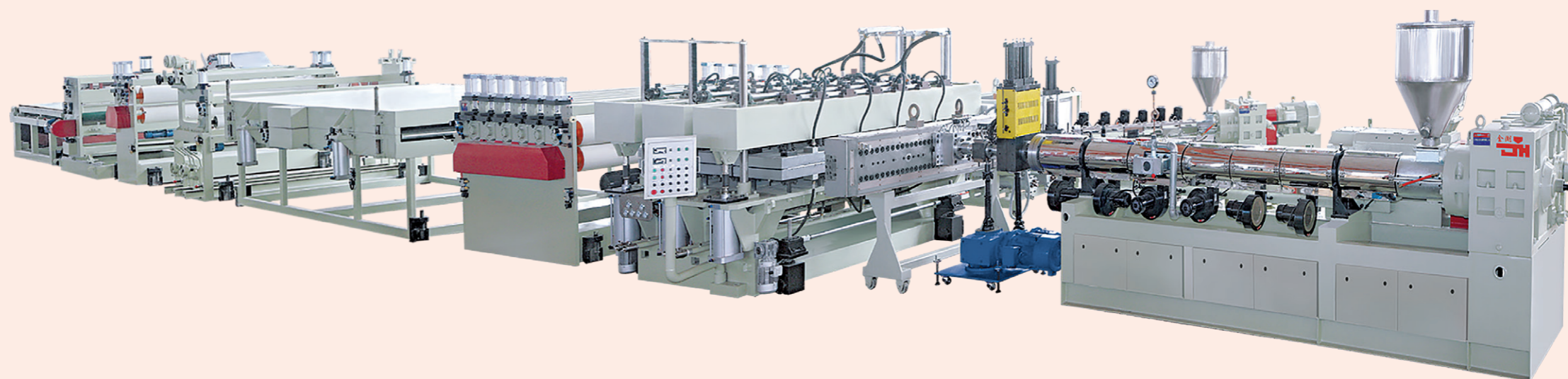

ABS

Single Layer, Multi-Layers Composite Sheet Production Line

ABS 单层、多层复合板材生产线

ABS 单层、多层复合板

具有耐冲击强度高,耐热性能好,韧性好,表面光洁度高,易二次加工成型等特点。

广泛应用机械,电器,电子,卫生洁具,包装,医疗器械,休闲汽车、船舶马达外壳,户外电器外壳,旅游度假设施,玩具,仪器仪表,日用家具,餐盘,汽车内饰及门板等领域。

加工范围:单层、双层、三层、五层 厚度:0.6-10mm 宽度:3000mm 以内

ABS Single Layer, Multi-Layers Composite Sheet

It has such characteristics as high impact-resistance, high heat resistance, high surface roughness, easy to thermoform, etc.

Applications: such as machinery, electrical, sanitary ware, packing, medical treatment apparatus, carriage, outer shell, toy, dining plate, etc.

Production scope: single layer, double layer, three layer, five layer.

Thickness: 0.6~10mm width: 3000mm(under)

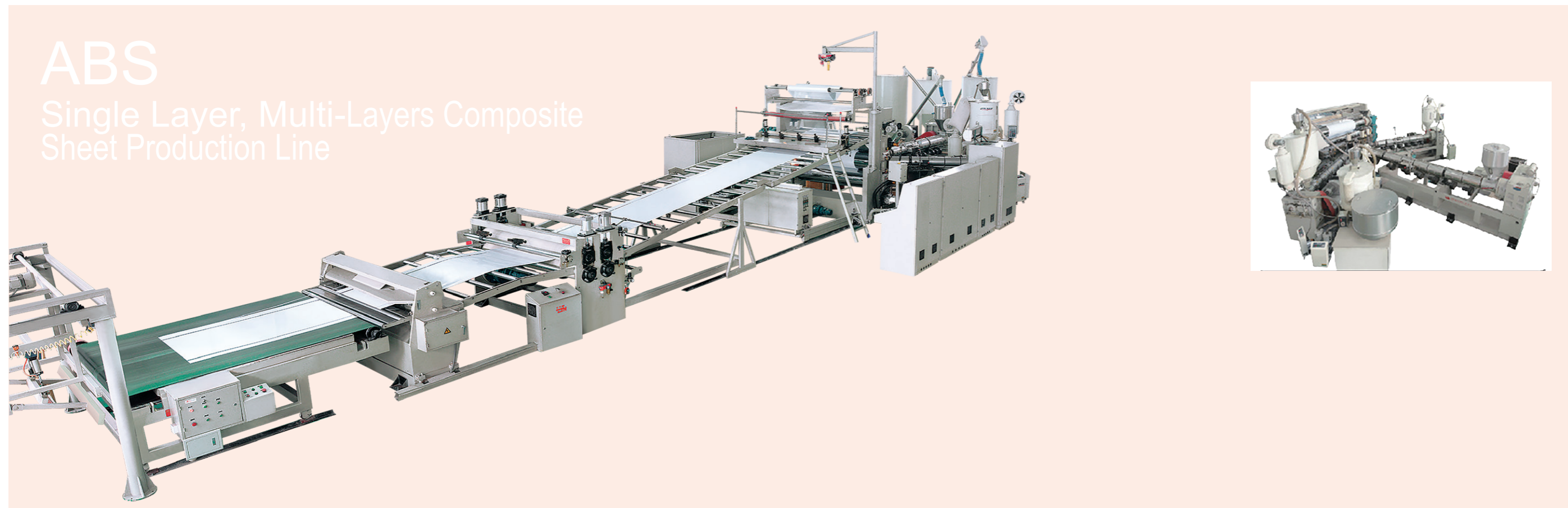
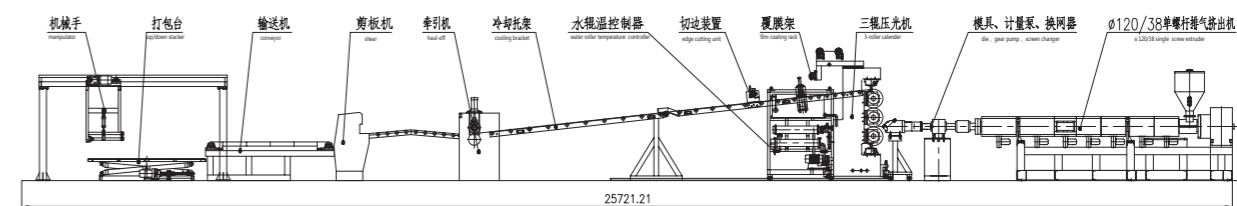

ABS

Single Layer, Multi-Layers Composite Sheet Production Line

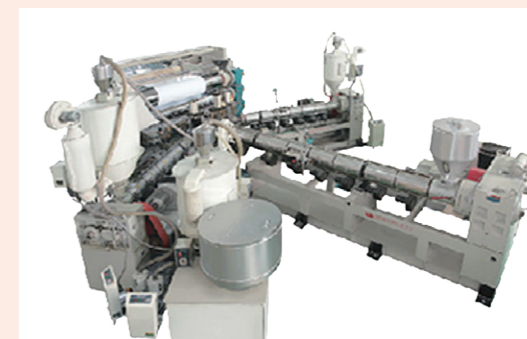

ABS. PP.PS

Anti-static co-extrusion sheet production line

ABS、PP、PS 防静电塑料片材生产线

通过片材涂布达到防静电的效果，经过涂布，防静电系数在 10 次方以内。

After coating can anti-static, anti-static coefficient less than 10 th

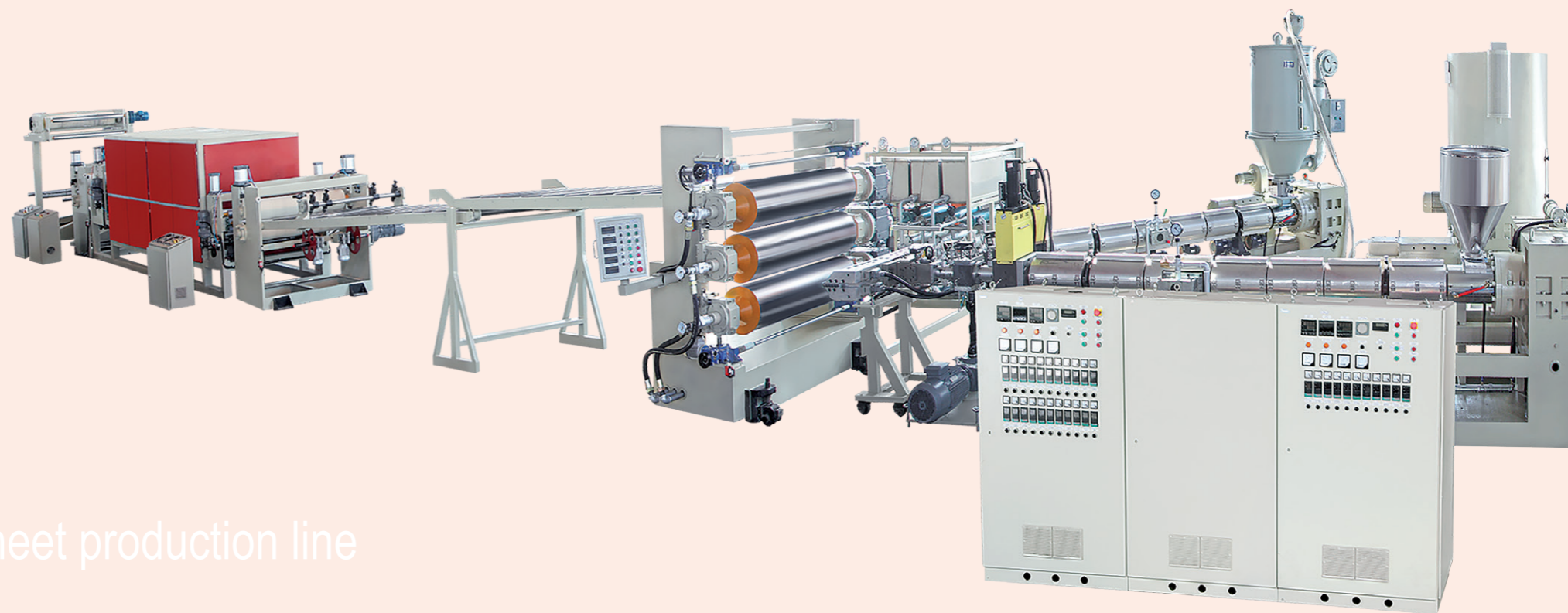
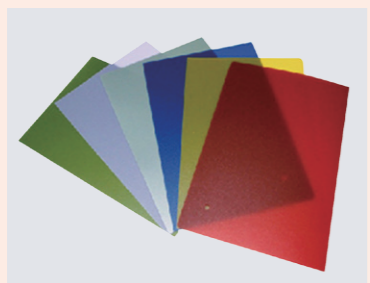
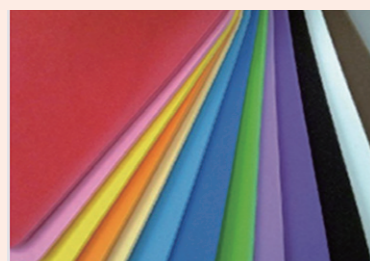
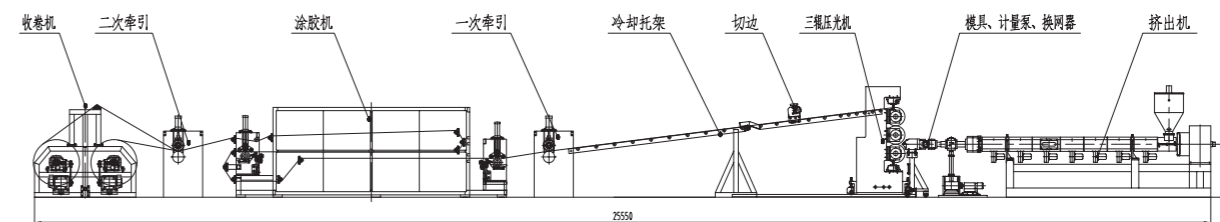

ABS. PP.PS

Anti-static co-extrusion sheet production line

PVC

Foamed Skinning Board Production Line PVC 半结皮发泡板材共挤生产线

产品用途:

交通运输业: 轮船、飞机、客车、火车车厢、顶棚、厢体芯层、内部装潢板。
建筑、装潢业: 建筑物外墙板、内装饰用板、住宅、办公室、公共场所建筑间隔、商用装饰架、无尘室用板、吊顶板、厨具、洁具。
广告业: 网板印刷、电脑刻字、广告标牌、展板、标志用板。
工业应用: 化工防腐工程、热成型件、冷库用板、特殊保冷工程、环保用板。
其它用途: 模板、运动器材、养殖用材、海滨防潮设施、耐水用材、美工材料各种轻便隔板。加工范围: 厚度 3-18mm 宽度 1220mm

Applications Of Product

Transportation: such as steamship, aeroplane, carriage, train compartment, roof shed, case core layer, inner upholster, etc.
Architecture: such as building wall board, decoration board, housing, office, public building interlayer, commercial decoration shelf, non-dust room board, ceiling plate, etc.
Advertisement: such as screen printing, computer lettering, ad board, etc.
Industry: such as chemical industry antisepticizing project, thermoforming, for refrigeratroy, for temperature keeping, for environment protection, etc.
Other applications: such as mould plate, sports equipment, breeding equipment, seashore wet-proof facility, water-fast material, art material, various interlayer, etc.
Production scope: thickness 3-18mm, width 1220mm

PVC 半结皮发泡板材生产线是我公司通过多年生产发泡板材生产线经验, 结合 PVC 自由发泡板材生产线和 PVC 结皮发泡板材生产线自主研发的一种新型发泡板材生产线。产品具有密度低、表面硬度高、平整度好等优点。

PVC foamed skinning board production line is made and designed by our company through many years experience involving in manufacturing PVC free foamed board production line and PVC crush foamed board production line. PVC foamed skinning board product has such characteristics as low density, high surface hardness, good smoothness, etc.

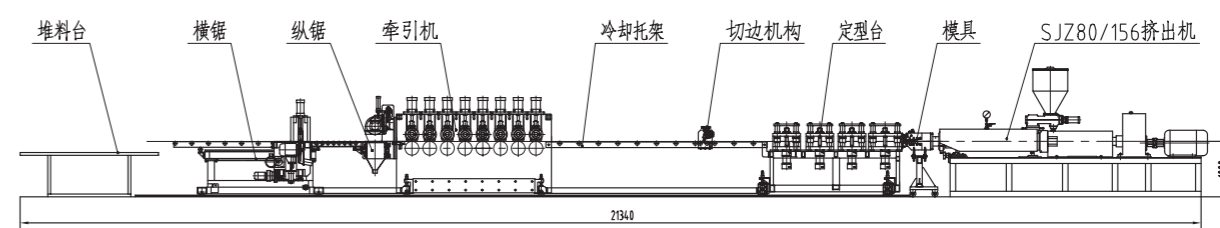
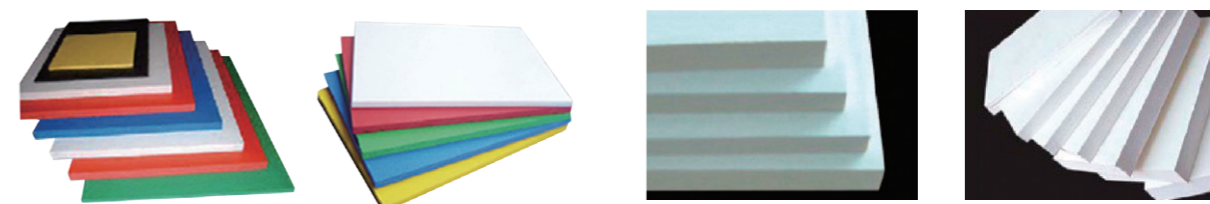

PVC

Crust Foamed Plate Production Line PVC 结皮发泡板材生产线

产品特点和功能

PVC 结皮发泡板材，具有隔音、吸音、隔热、保温等性能。板质具有阻燃性，能自熄不虞火灾，可以安全使用。各系列产品都有防潮、防霉、不吸水的性能，而且防震效果好。各系列产品经耐候配方制成后，其色泽可长久不变，不易老化。本产品质地轻，储运、施工方便。本产品使用一般木材加工工具即可施工。可像木材一样进行钻、锯、钉、刨、粘等加工。适用于热成型，加热弯曲及折叠加工。可根据一般焊接程序焊接，亦可与其它 PVC 材料粘接。本产品其表面光滑，可印刷。（印刷前需擦拭干净表面）。

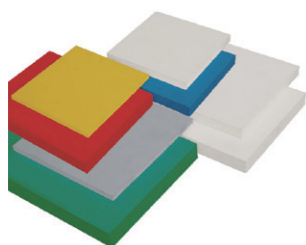

Characteristics And Functions Of Products

VC crust foamed plate has such characteristics as sound separation, sound absorption, heat separation, temperature- keeping, etc. The material is incombustible, it is safe for use. All series of products have property of moisture proof, mildew proof, water resistance, its vibration resistant effect is good. All series of products have property of weathering proof, its luster may remain forever, it is not easy to be ageing. This product is light, storage & transport, construction are rather convenient. This product can be worked with normal tools for wooden material. Drilling, sawing, nail, planing, bonding can be conducted like wooden material. It is suitable for thermal shaping, thermal bending and fold processing. It can be welded, it can also be bonded with other PVC material. The surface of this product is smooth, it can be printed. (Clean the surface before printing.)

产品用途

交通运输业：轮船、飞机、客车、火车车厢、顶篷、厢体芯层、内部装潢用板。**建筑装饰业：**建筑物外墙板、内装饰用板、住宅、办公室、公共场所建筑物隔间、商用装饰架、无尘室用板、吊顶板。**广告业：**网板印刷、电脑刻字、广告标牌、展板、标志用板。**工业应用：**化工防腐工程、热成型件、冷库用板、特殊保冷工程、环保用板。**其它用途：**模板、运动器材、养殖用材、海滨防潮设施、耐水用材、美工材料、各种轻便隔板。

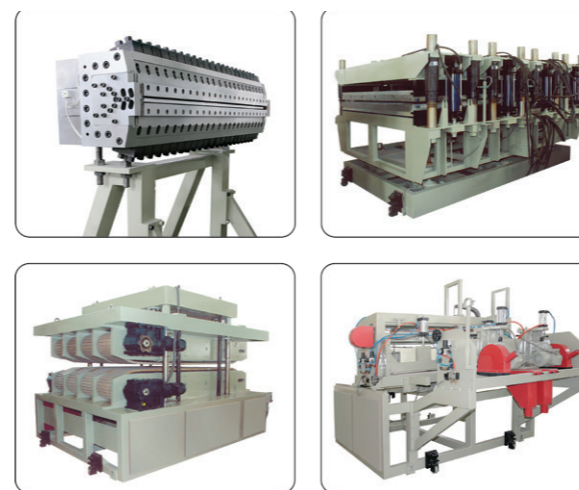

Applications Of Product

Transport industry: ship, plane, bus, train, floor covering, core layer, indoors decoration plate.
Architecture decoration industry: outdoors plate, indoors decoration plate, residential house, office, separation of public building, commercial decoration frame, plate used in dust-free room, ceiling plate.
Advertisement industry: screen printing, computer engraving, ad. board, exhibition plate, logo plate.
Industrial application: rot proof project in chemical industry, thermal shaped part, plate for refrigeration warehouse, special cool-keeping project, environmental protection plate.
Other applications: construction mold plate, sports apparatus, aquaculture material, seashore wet-proof facility, water-resistant material, arts material and all sorts of light separation plate.

PVC 发泡板物理性能指标 Physical properties of PVC foam plates

检测项目 inspection&testing items	单位 unit	检测结果 Testing results
表面密度 surface density	g/cm ³	0.5-0.8
拉伸强度 tensile strength	MPa	12-20
弯曲强度 bending strength	MPa	12-18
弯曲弹性模量 bending modulus of elasticity	MPa	800-900
冲击强度 impulsive strength	KJ/m ²	8-15
断裂伸长率 breakage elongation	%	15-20
邵氏硬度 Shao's hardness	D 型	45-50
吸水性 water absorption	%	≥ 1.5
维卡软化点 softening point	℃	73-76
阻燃性 fire resistance		离火自熄小于 5 秒 automatic extinguishment time is less than five seconds in case of fire

规格及标准设备若有变动，恕不另行通知
Specifications and standard equipment are subject to change without prior notice



PVC Crust Foamed Plate Production Line

PVC

Free Foamed Sheet, Board, Production Line

PVC 自由发泡板、厚板生产线

PVC 自由发泡板材

交通运输业: 轮船、飞机、客车、火车车厢、顶棚、厢体芯层、内部装潢板。

建筑、装潢业: 建筑物外墙板、内装饰用板、住宅、办公室、公共场所建筑间隔、商用装饰架、无尘室用板、吊顶板、厨具、洁具。

广告业: 网板印刷、电脑刻字、广告标牌、展板、标志用板。
工业应用: 化工防腐工程、热成型件、冷库用板、特殊保冷工程、环保用板。

其它用途: 模板、运动器材、养殖用材、海滨防潮设施、耐水用材、美工材料各种轻便隔板。

加工范围: 厚度 1-15mm 宽度 1200-2400mm

PVC Free Foamed Sheet

Transportation: such as steamship, aeroplane, carriage, train compartment, roof shed, case core layer, inner upholster, etc.

Architecture: such as building wall board, decoration board, housing, office, public building interlayer, commercial decoration shelf, non-dust room board, ceiling plate, etc.

Advertisement such as screen printing, computer lettering, ad board, etc.

Industry: such as chemical industry antisepticizing project, thermoforming, for refrigeratroy, for temperature keeping, for environment protection, etc.

Other applications: such as mould plate, sports equipment, breeding equipment, seashore wet proof facility, water-fast material, art material, various interlayer, etc.

Production scope: thickness 1-15mm, width 1200-2400mm

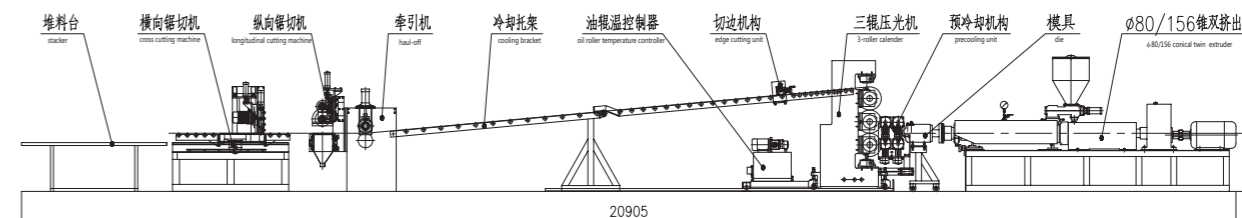
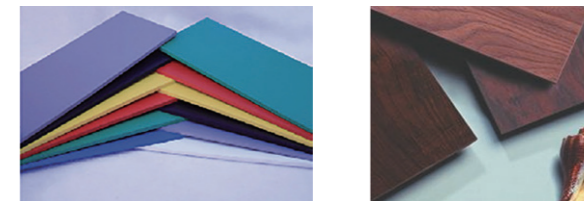

PVC
Free Foamed Sheet, Board, Production Line

PVC

Edge Banding Production Line

PVC 封边条生产线

PVC 封边条制品:

主要用途: 家具、办公用品的贴面、封边、包装吸塑等
主要特点: 产品塑化效果好, 强度高, 颜色多样化控制精确。生产效率高, 可替代 PVC 压延片使用。

产品厚度: 0.2-2mm

产品亮度: 630-1000mm

PVC edge banding products:

Main application: vanner, edge banding, skin packing of furniture and office accommodation.

Main feature: product with good plaseification high tension, product colour variely, precison control, high production efficiency and can replaced PVC calendered sheet.

Product thickness: 0.2-2mm

product widen: 630-1000mm

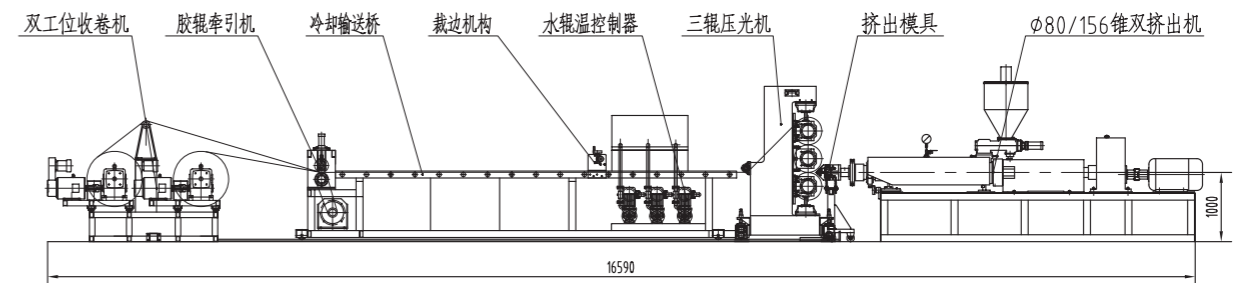

Wide Floor Sheet

Waterproof Sheet Production Line

宽幅地板格、防水卷材生产线

PVC、PP、PE 单层、多层复合地板，广泛用于汽车、火车、机场、宾馆等公共场所，以及家庭装潢。
PVC、PP、PE 防水卷材，广泛用于隧道排水、地基防潮、屋顶防漏、垃圾填埋等工程领域。加工范围：厚度 1-8mm 宽度 6000mm 以内

PVC, PP, PE single layer, multi-layers composite floor sheet, widely used in carriage, train, airport, hotel, public building, house decoration, etc.

PVC, PP, PE water proof sheet, widely used in tunnel drainage, foundation wetproof, roof leakproof project, etc.

Production scope: thickness 1 -8mm, width: 6000mm(under)

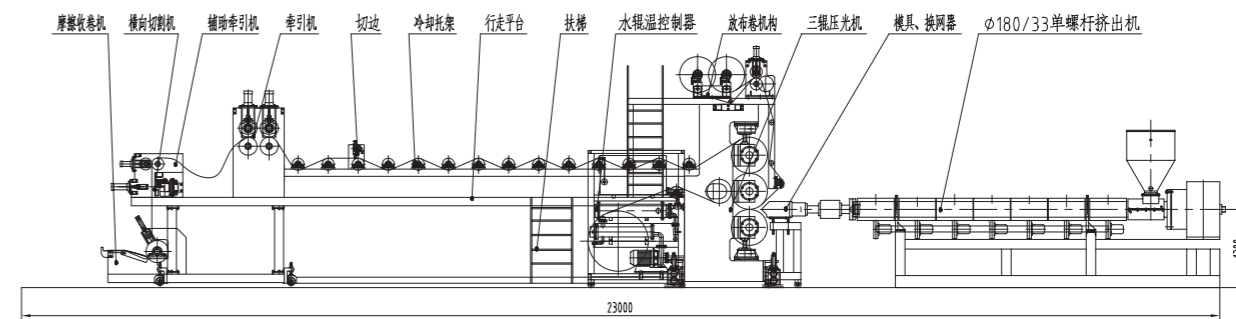
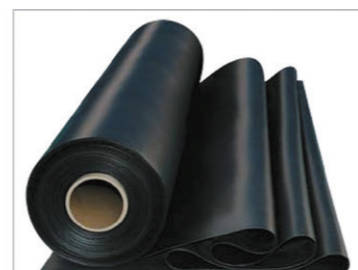

Wide Floor Sheet
Waterproof Sheet Production Line

APET.PETG.CPET

Sheet Extrusion Line/Dryer-free PET Double Vented Sheet Extrusion Line

APET, PETG, CPET 片材生产线 / 免干燥 PET 双排气生产线

APET、PETG、CPET 单层及多层共挤片材生产线

是目前国内技术最先进、工艺最成熟、设备最稳定的片材生产线之一，与国内同类设备相比，综合效能高 30% 以上，此生产线同时也可用于生产 PS、PP、PE 等片材制品

免干燥新型 PET 双排气挤出生产线

无需除湿干燥系统，是金湖公司最新研制的高质量 PET 片材机组，其生产工艺简单，能耗低、大大降低生产成本。

APET,PETG,CPET single-layer or multi-layer sheet extrusion machine

It's one of the most advanced production lines with matured technology and stability in China. Compared with other same kind equipment, it's over 30% higher in overall efficiency. Line is suitable for PS,PP,PE as well.

Dryer-free PET double venting sheet line

Free of crystallization drying system, the new designed line can greatly reduces cost of production.

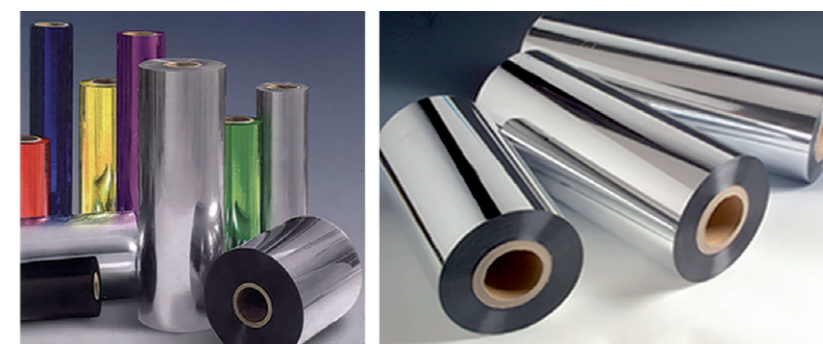
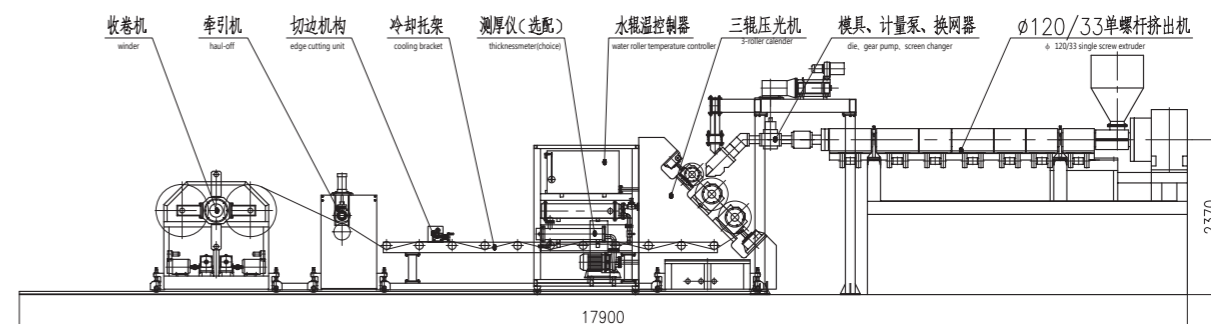

APET.PETG.CPET
Sheet Extrusion Line/Dryer-free PET Double
Vented Sheet Extrusion Line

CJMFH1300/1600-C

Aluminum Composite Panel Production Line

铝塑板复合生产线

我公司最新研制的 CJMFH1300/1600-C 铝塑复合板生产线是在我公司前二代产品基础上结合德国及韩国生产线特点开发的新一代铝塑复合板生产线。通过对复合部份的改进，这样可以使铝卷、高分子膜和 PE 在复合时一次成型并且效果更佳。此新型设备与老型号相比不仅可以大大节约能源而且操作更为简便，合格率更高，应用广泛，维护方便。此设备生产 B1 防火板更为合适。

Our new CJMFH1300/1600-C Aluminum composite panel product line is the third times machine which we combined Germany and Korean technique to develop. Through do some upgrade to the composite parts, it can make the aluminum coil, macromolecule film and PE compound better in one time. Compares to the old machine, the new machine can save more power, control easily, have higher eligible rate, apply widely and conveniently of maintain. The new machine is more suitable for producing B1 fireproof panel.

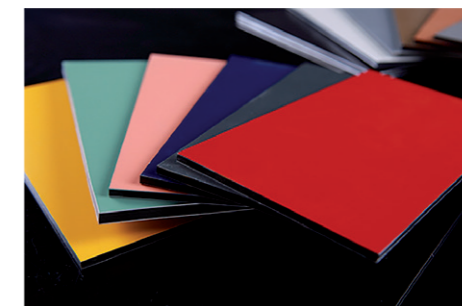

CJMFH1300/1600-C

Aluminum Composite Panel Production Line

